

SEM1700

USER INSTRUCTIONS

Important - Please read this document before installing.

Every effort has been taken to ensure the accuracy of this document; however, we do not accept responsibility for damage, injury, loss or expense resulting from errors and omissions, and we reserve the right of amendment without notice.

IMPORTANT – CE, UKCA & SAFETY REQUIREMENTS

Product must be DIN rail mounted, inside a suitable enclosure providing environmental protection to IP65 or greater.

To maintain CE EMC requirements, input and supply wires must be less than 30 metres.

The product contains no serviceable parts, or internal adjustments. No attempt must be made to repair this product. Faulty units must be returned to supplier for repair.

Before attempting any electrical connection work, please ensure all supplies are switched off.

| ABSOLUTE MAXIMUM CONDITIONS (To exceed may cause damage to the unit). | |
|--|---|
| Working voltage terminals 1 to 10 | ± 30 V dc, ± 50 mA dc |
| Working voltage terminals 11 to 18 | 240 V ac, ± 240 V dc |
| Isolation (11 to 12) to (1 to 10) | 3750 V |
| Isolation (11 to 12) to (13 to 18) | 3750 V |
| Isolation (13 to 18) to (1 to 10) | 3750 V |
| Supply voltage | ±240 V dc, ±240 V ac (protected for over voltage) |
| Input voltage | ±24 V between any input terminals |
| Input current | ±50 mA between any input terminals |
| Output | 30 V dc |
| Relays | (240 V ac @ 1 A, 30 V dc @ 1 A) non inductive |
| Ambient Temperature (-20 to 70) °C, Humidity (0 to 95) % RH (Non-condensing) | |
| External supply | 1 A anti-surge fuse recommended |



Important – Read this document before installing.

1~DESCRIPTION.

The SEM1700 is a DIN rail-mounted universal signal conditioner from Status Instruments. It has been designed to accept most common process and temperature sensor inputs and provide the user with a programmable current or voltage output signal, plus dual relays with a programmable delay function. Isolation is provided between input, output and supply. All temperature ranges are linear to temperature. Both input and output loop excitation are provided, as well as a universal power supply.

2~RECEIVING AND UNPACKING.

Please inspect the packaging and instrument thoroughly for any signs of transit damage. If the instrument has been damaged, please notify your supplier immediately.

3~SPECIFICATION.

Refer to data sheet for full specification. Download at www.status.co.uk

| | |
|------------------|--|
| Factory defaults | Input Pt100, output (4 to 20) mA = (0 to 100) °C relays high alarm @ 50°C, damping off, buttons off, Sample rate 1000 ms |
|------------------|--|

4~INSTALLATION AND WIRING.

Important safety requirements

This equipment is suitable for environment installation category II pollution degree 1 and is classed as "PERMANENTLY CONNECTED EQUIPMENT".

In NORMAL USE, the equipment will only be accessed for maintenance by qualified personnel. Please ensure the equipment is mounted vertically with terminals (1-10) at the bottom. This will provide maximum ventilation and ensure correct operation of the cold junction sensor. This equipment may generate heat; ensure the enclosure size is adequate to dissipate heat. Be sure to consider any other equipment inside the enclosure.

The equipment surfaces may be cleaned with a damp cloth. Use a mild detergent on a damp cloth. Ensure the supply is off before cleaning and on completion of cleaning the equipment is completely dry before the supply is turned back ON.

To keep the safety distances, the relay on the device must not be connected to both hazardous and non-hazardous voltages.

This equipment must be installed by a qualified person. All electrical wiring must be carried out in accordance with the appropriate regulations for the place of installation.

Dc supply must be derived from a local supply and not a distribution system.

Supply (22 to 240) V ac 50/60 Hz, (20 to 240) V dc. If the supply is a HAZARDOUS VOLTAGE, a supply isolation switch must be installed close to the equipment with the

"OFF" position clearly marked. Also, the supply must be fused with a suitable 1A (T) fuse (circuit breaker) installed close to the equipment. Maximum cable run 50 m.

Relay 1,2 outputs are isolated from each other. Max switching current (1 A @ 240 V ac, 1 A @ 30 V dc) Non-Inductive. Fuse relay circuits with a suitable 2A (T) fuse installed close the equipment. If a HAZARDOUS VOLTAGE is being switched, then an isolation switch must also be installed close to the equipment with the off position clearly marked.

USB configuration can be performed without the supply being connected. For safety reasons, use a 24 VDC for functional test of unit prior to fixed installation. The following operations should only be carried out on a disconnected device and under ESD safe conditions.

4.1~MECHANICAL.

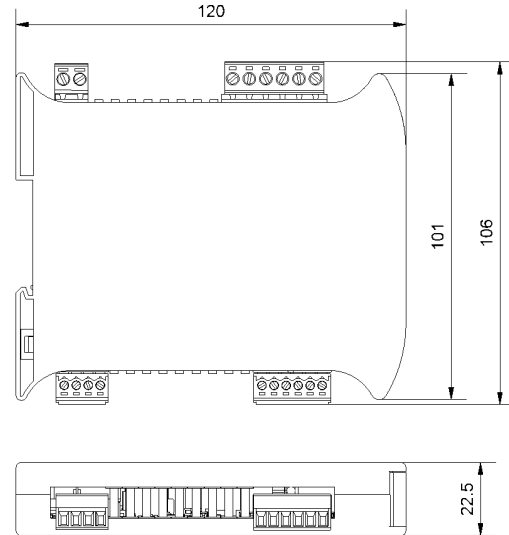

The equipment must be mounted on a DIN rail style DIN EN 50022 inside a plastic or metal enclosure with a protection level >= IP65. All wiring must be secured. Maximum cable sizes 2.5 mm. Connection two-part screw terminals.

4.2~ELECTRICAL CONNECTIONS

For wiring connections refer to the side label on the SEM1700 and this document.

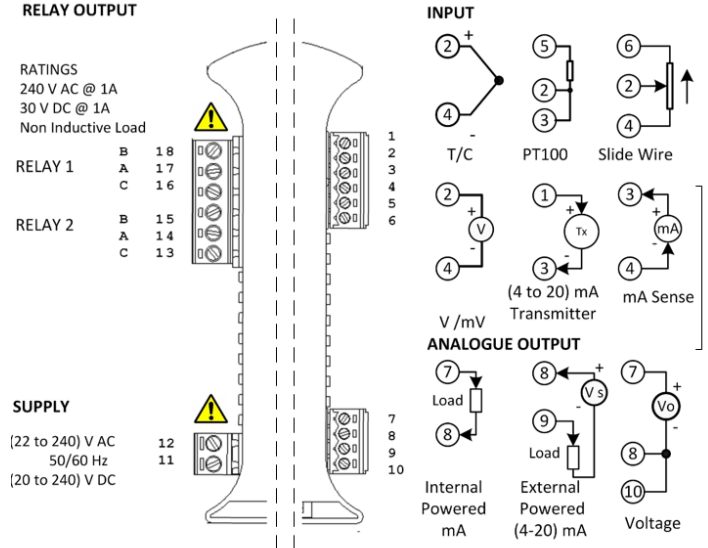

Input connections for cable length >3 metres use screen or twisted pair cables. Thermocouple connections: use the correct compensating cable. Pt100 connection; all wires must be equal length (resistance). Max cable run 30 metres.

Output connections for cable length >3 metres use screen or twisted pair cables. For current outputs max cable run 1000 metres, Voltage output 30 Metres.

Relay connections – relays 1 and 2 are isolated from each other. As stated in the IMPORTANT SAFETY REQUIREMENTS relay circuit must be fused with a 2A (T) fuse and provision provided to isolate the circuit when hazardous voltages are being switched.

Supply maximum cable run 30 metres. As stated in the IMPORTANT SAFETY REQUIREMENTS the supply must be fused with a 1A (T) fuse and provision provided to isolate the circuit when hazardous voltages are being switched.

5-USER CONFIGURATION.



Read the Important safety requirements

5.1-MANUAL CONFIGURATION

User trim function allows manual adjustment of the analogue output. This is useful for minor calibration adjustment or trimming out any sensor error; $\pm 5\%$ of range adjustment is available at both offset and span. Raise and lower buttons are provided on the front panel of the transmitter, accessed using a 3 mm flat blade screwdriver. Insert the screwdriver into the appropriate slot to operate the button. The button has a click action.

The transmitter will automatically detect the correct trim point (offset or span) based on the output signal. Offset will be trimmed when the current is in the offset band, span when the current is in the span band. No trim action occurs at any input value.

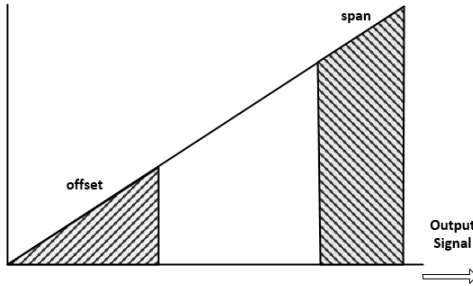

| Range | Offset | Span |
|--------------|--------------------------------|----------------------------------|
| (4 to 20) mA | (3.8 to 6) mA | (18 to 22) mA |
| (0 to 20) mA | (0 to 2) mA | (18 to 22) mA |
| User mA | User low ± 2 mA (Min 0 mA) | User High ± 2 mA (Max 24 mA) |
| (0 to 10) V | (0 to 1) V | (9 to 11) V |
| User V | User low ± 1 V (Min 0 V) | User High ± 1 V (Max 12 V) |

| User trim method (option selected in software) |
|--|
| Connect the device to a suitable input simulator/sensor. Connect a digital meter to monitor the output. Turn on device, set input to offset/span trim point. |
| Enter trim menu by pressing Δ for > 2 s. |
| When the trim menu is open the STATE LED will flash as shown below. |
| If performing two-point trim always trim, offset point first. |

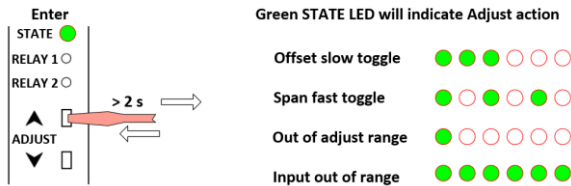

| User trim method (continued) |
|--|
| Adjust output current by pressing either the Δ or ∇ button, single click to step advance, or press continuously to auto advance. |
| Once adjust is complete, allow 30 s with no button press. The transmitter will time out and return to normal operation. |

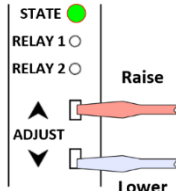

User range function allows two-point manual configuration of the re-transmission current (voltage) at low and high range against a live input signal. This is useful for on-site configuration. Example, with a slide wire input, the user manually positions the slide at both low and high positions and configures the unit to operate over the range. Configuration is achieved using either the raise (span) or lower (offset) buttons.

| User range method (option selected in software) |
|---|
| Connect the device to a suitable input simulator/sensor. Connect a digital meter to monitor the output. Turn on device, set input to offset/span range point. |
| Enter range menu by pressing Δ or ∇ for > 2 s. |
| When the trim menu is open the STATE LED will flash as shown below. |

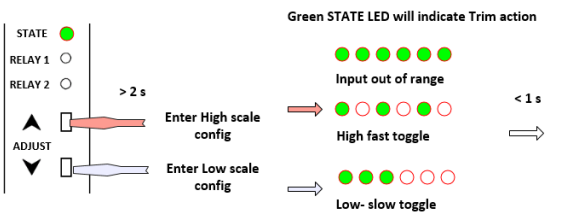

| User trim method (continued) |
|--|
| Once the menu has been entered, quickly (within 1 s) Δ or ∇ button to enter and store setting. |
| To abort configuration, allow config to time out by not pressing buttons for 5 s. |

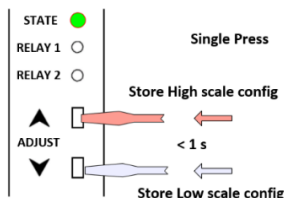

5.2-PC CONFIGURATION

During configuration the equipment takes its power from the USB port, therefore no power connection is required. The equipment can be configured whilst powered but the computer used must be isolated from the supply earth to avoid grounded earth loop effects.

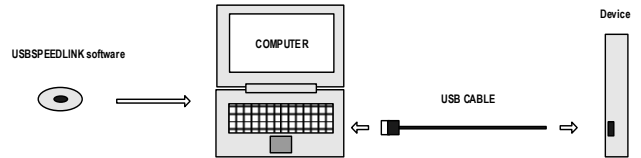

| Configuration steps using USBSpeedLink |
|--|
| Download install and run USBSpeedLink |
| Connect device to PC using an A to mini B USB lead |
| Upload device set-up into the configuration software |
| Adjust settings as required |
| Send new configuration to the device |

USBSpeedLink software configuration screen for SEM1700

Note: When the device is correctly connected, the "Send" and "Receive" menu buttons will turn black and the "data" section of the screen will open on the right.

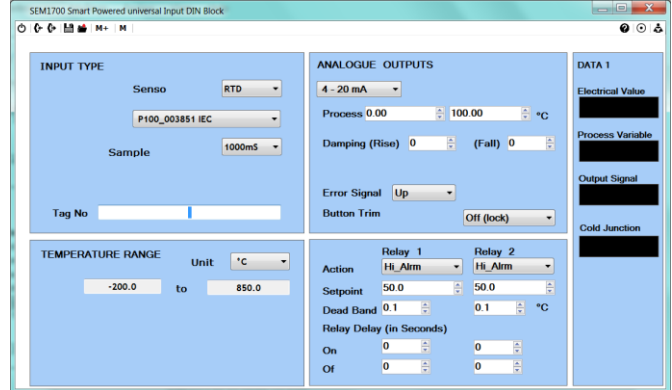

INPUT TYPE

Select input sensor, or process type required. Also used for adjustable sample time and gives a user-field to save text to the device

TEMPERATURE RANGE/SCALE PROCESS

Set the unit and range in temperature mode, and engineering units and scaling range in process mode.

ANALOGUE OUTPUTS

Select mA or voltage output, either pre-set ranges or a user-defined range can be entered.

User-adjustable damping of the analogue output is provided for both rising and falling signals. The adjustable range is (0 to 250) second for a (0 to 20) mA or (0 to 10) V swing. To calculate the maximum rate of change of the output signal, divide 20 mA (10 V) by the damping setting. Example, if the damping is set to 100 s, the mA output will change at a maximum rate of $(20/100) = 0.2$ mA/s.

Error signal direction for temperature mode.

Front of panel button function control for user trim, user range and off is selectable.

RELAY 1 and RELAY 2

The contacts are rated at 240 V ac 1 A (Non inductive) 30 V DC 1 A. An external snubber network is recommended when switching inductive circuits. Please ensure the snubber network is rated for the application. Four actions are provided, as detailed below.

Alarm actions may also be used for inverted control applications. Adjustable setpoint and dead-band are provided together with adjustable on and off delays for each relay. The delay range is (0 to 250) s.

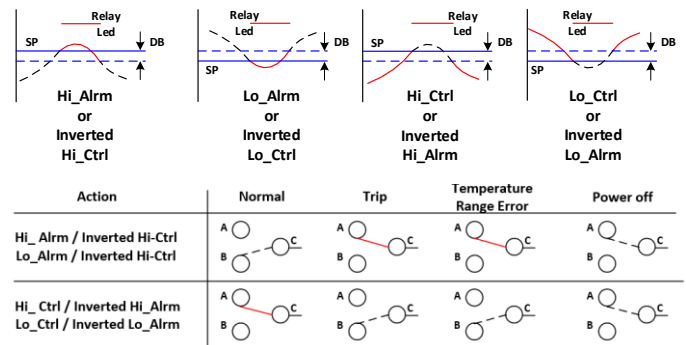

USBSpeedLink configuration software is available online at www.status.co.uk

This guide is also available online at www.status.co.uk

Status Instruments Ltd, Status Business Park, Gannaway Lane, Tewkesbury, Gloucestershire, UK, GL20 8FD,

Web Page: www.status.co.uk,

Email: sales@status.co.uk

Technical Support: support@status.co.uk

Tel: +44 (0) 1684 296818, Fax: +44 (0) 1684 293746